

SHINDENGEN

Schottky Rectifiers (SBD)

Dual

DF10SC4M

40V 10A

FEATURES

- SMT
- $T_j 150^{\circ}\text{C}$
- P_{RRSM} avalanche guaranteed
- High current capacity with Small Package

APPLICATION

- Switching power supply
- DC/DC converter
- Home Appliances, Office Equipment
- Telecommunication

OUTLINE DIMENSIONS

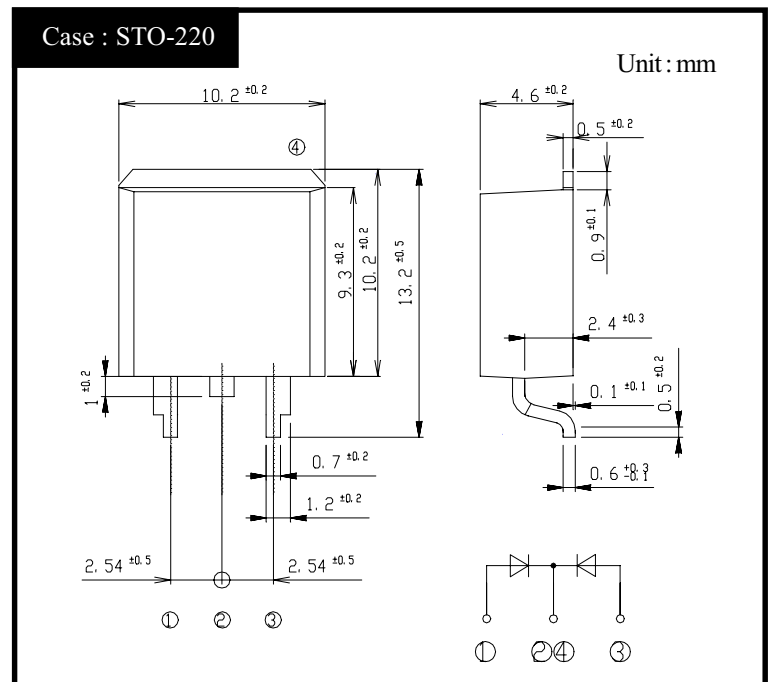

RATINGS

- Absolute Maximum Ratings (If not specified $T_c=25^{\circ}\text{C}$)

Item	Symbol	Conditions	Ratings	Unit
Storage Temperature	T_{stg}		-55~150	$^{\circ}\text{C}$
Operating Junction Temperature	T_j		150	$^{\circ}\text{C}$
Maximum Reverse Voltage	V_{RM}		40	V
Repetitive Peak Surge Reverse Voltage	V_{RRSM}	Pulse width 0.5ms, duty 1/40	45	V
Average Rectified Forward Current	I_o	50Hz sine wave, R-load, Rating for each diode $I_o/2$, With heatsink, $T_c=125^{\circ}\text{C}$	10	A
		50Hz sine wave, R-load, Rating for each diode $I_o/2$, On Al-Cu substrate, $T_a=33^{\circ}\text{C}$	6.8	
Peak Surge Forward Current	I_{FSM}	50Hz sine wave, Non-repetitive 1 cycle peak value, $T_j=125^{\circ}\text{C}$	100	A
Repetitive Peak Surge Reverse Power	P_{RRSM}	Pulse width 10 μ s, Rating of per diode, $T_j=25^{\circ}\text{C}$	330	W

- Electrical Characteristics (If not specified $T_c=25^{\circ}\text{C}$)

Item	Symbol	Conditions	Ratings	Unit
Forward Voltage	V_F	$I_F=5\text{A}$, Pulse measurement, Rating of per diode	Max.0.55	V
Reverse Current	I_R	$V_R=V_{RM}$, Pulse measurement, Rating of per diode	Max.3.5	mA
Junction Capacitance	C_j	$f=1\text{MHz}$, $V_R=10\text{V}$, Rating of per diode	Typ.180	pF
Thermal Resistance	θ_{jc}	junction to case	Max.3	$^{\circ}\text{C/W}$
	θ_{ja}	junction to ambient, On Al-Cu substrate	Max.25	

DF10SC4M Forward Voltage

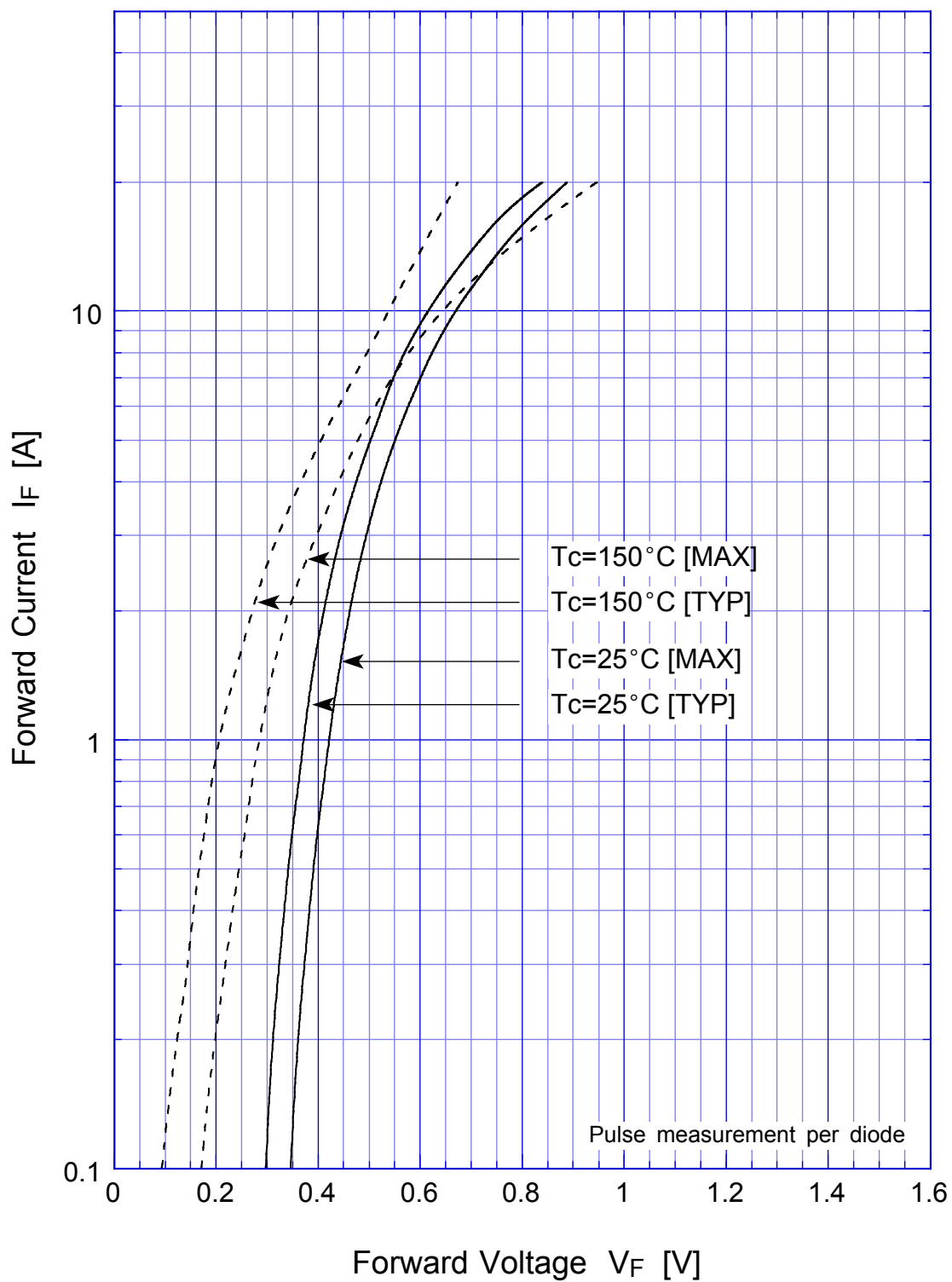

DF10SC4M Junction Capacitance

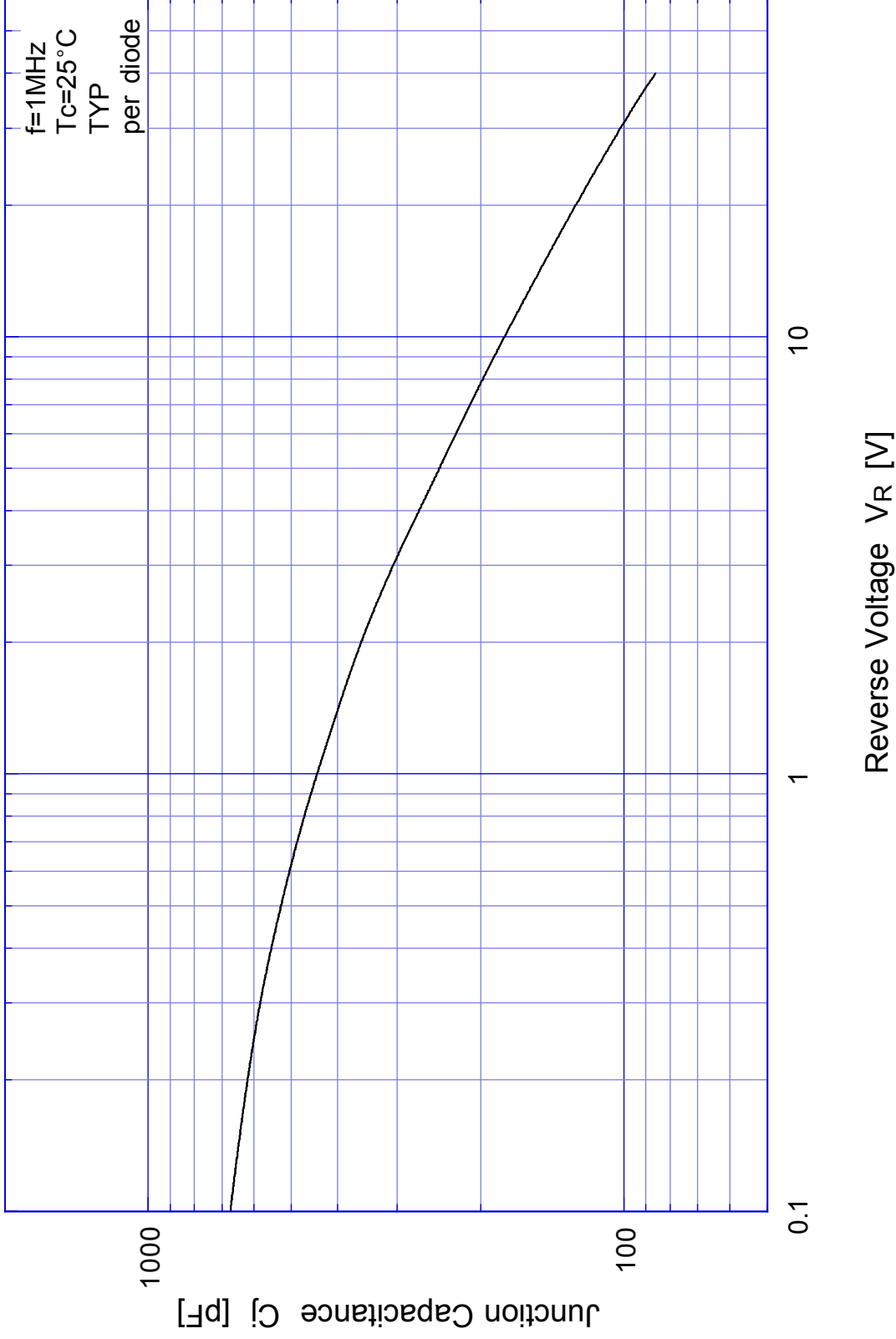

DF10SC4M Reverse Current

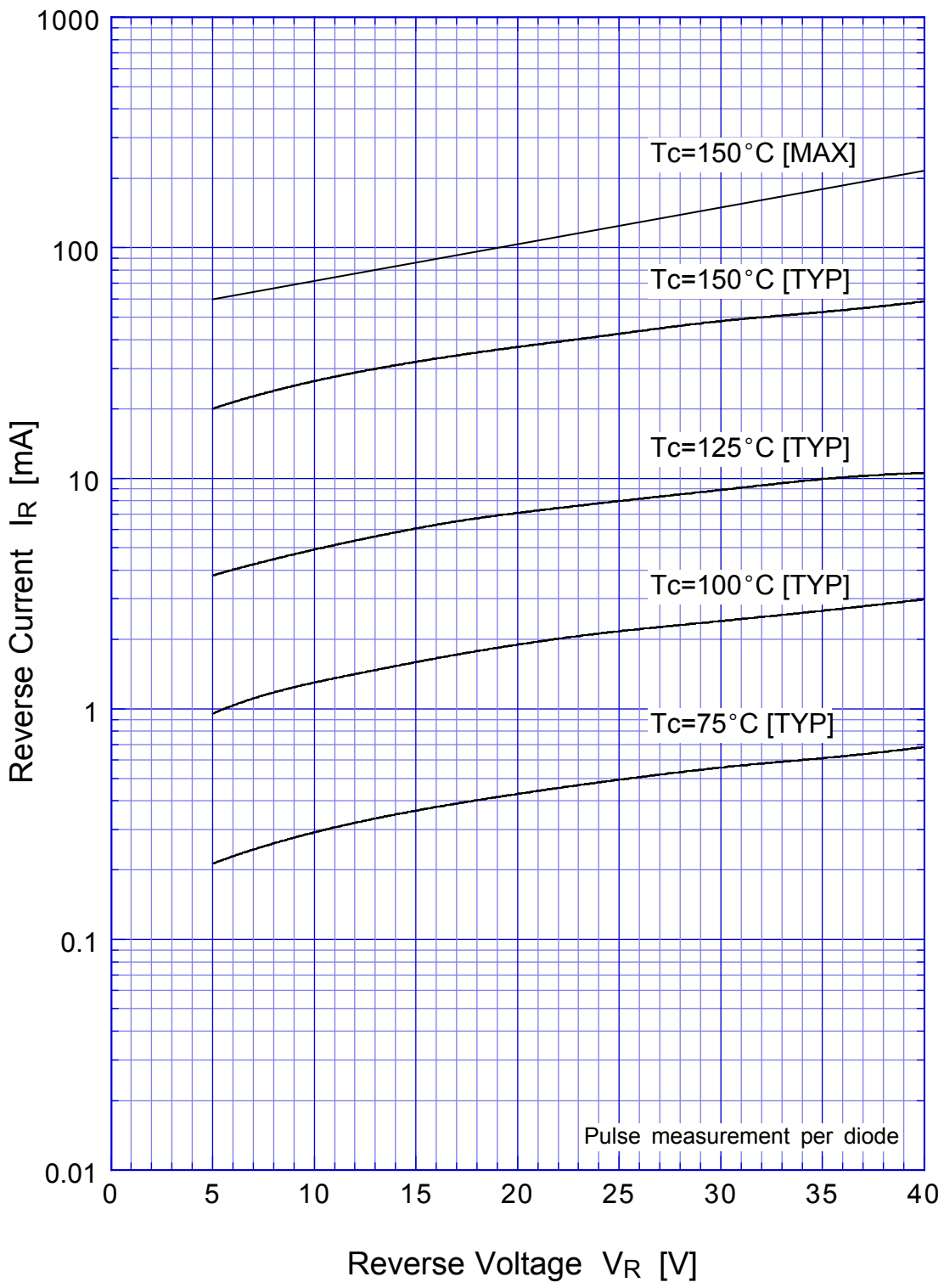

DF10SC4M Reverse Power Dissipation

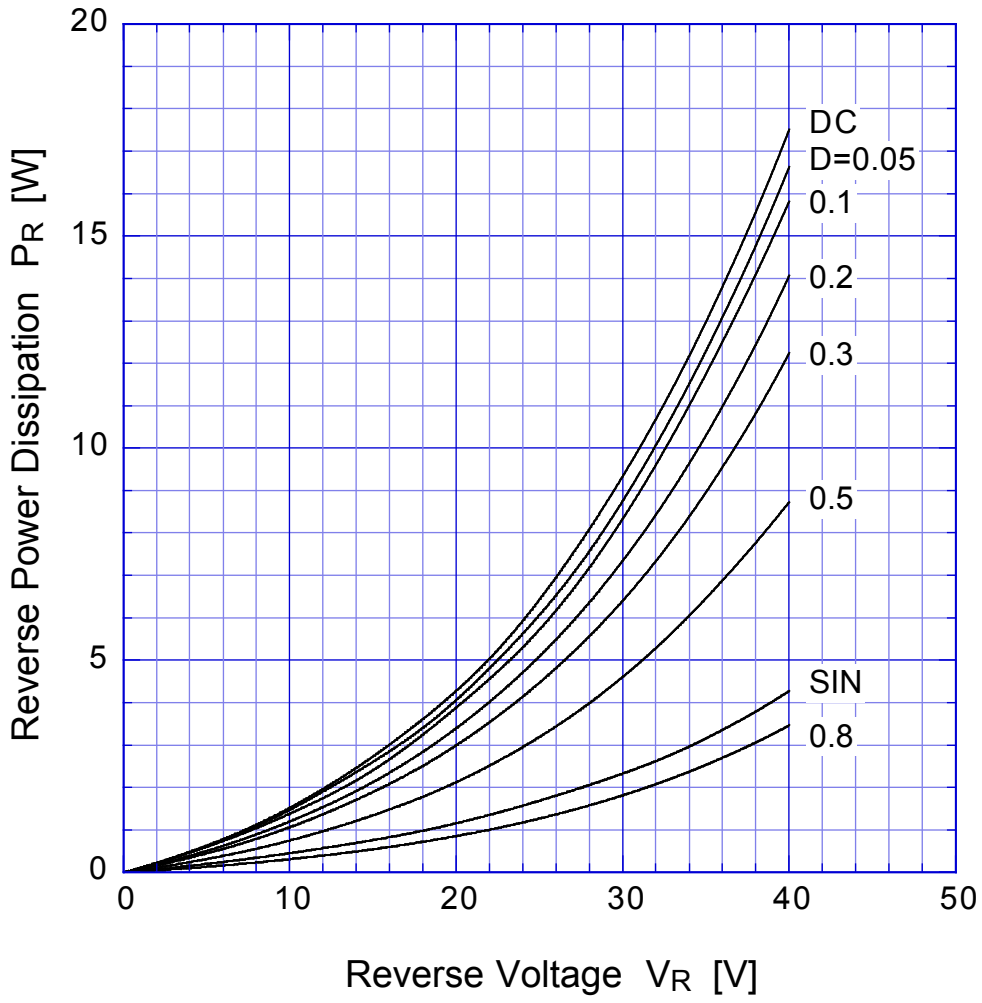

$T_j = 150^\circ\text{C}$

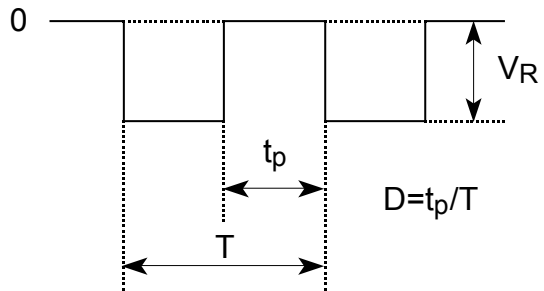

DF10SC4M Forward Power Dissipation

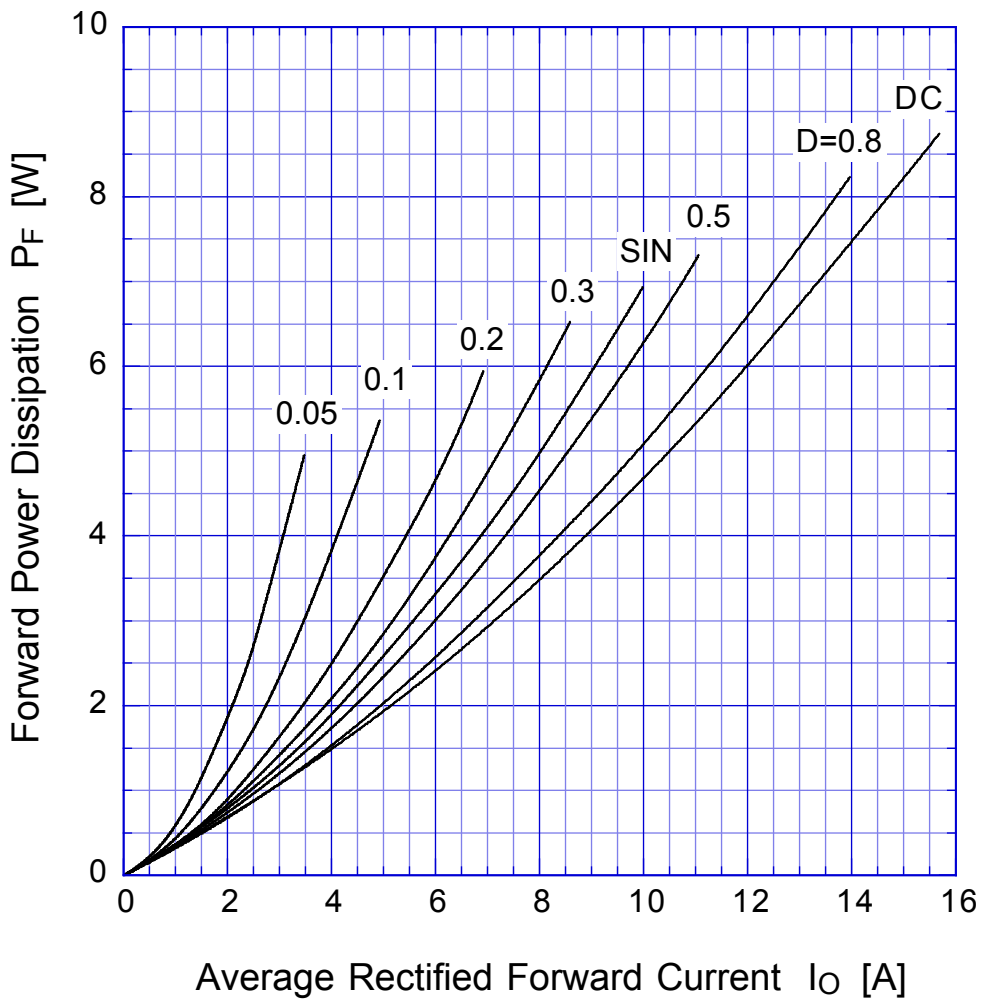

$T_j = 150^\circ\text{C}$

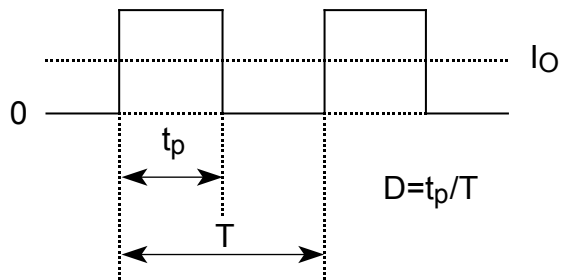

DF10SC4M

Derating Curve

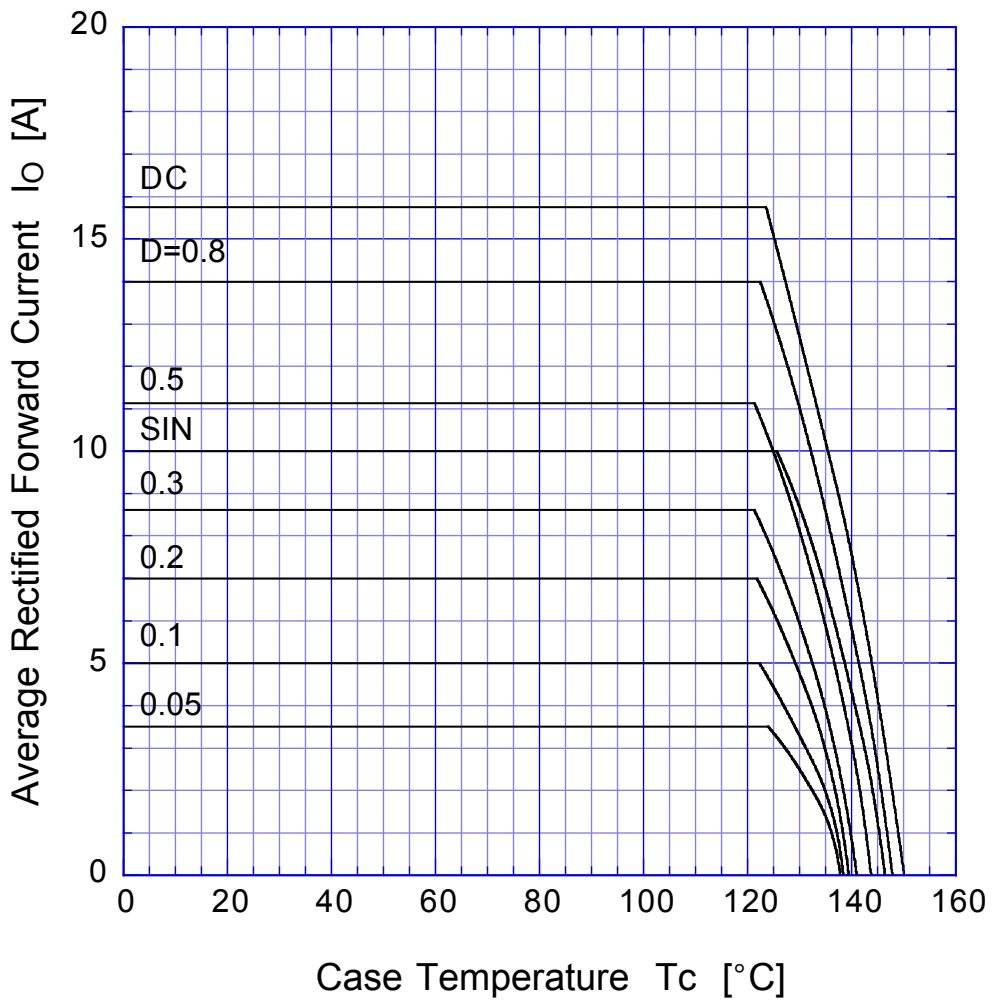

$V_R = 20V$

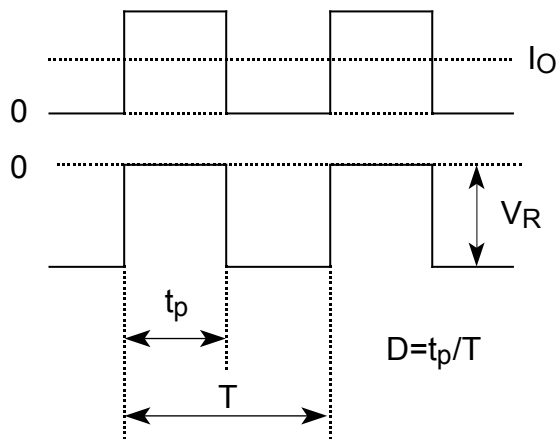

DF10SC4M

Derating Curve

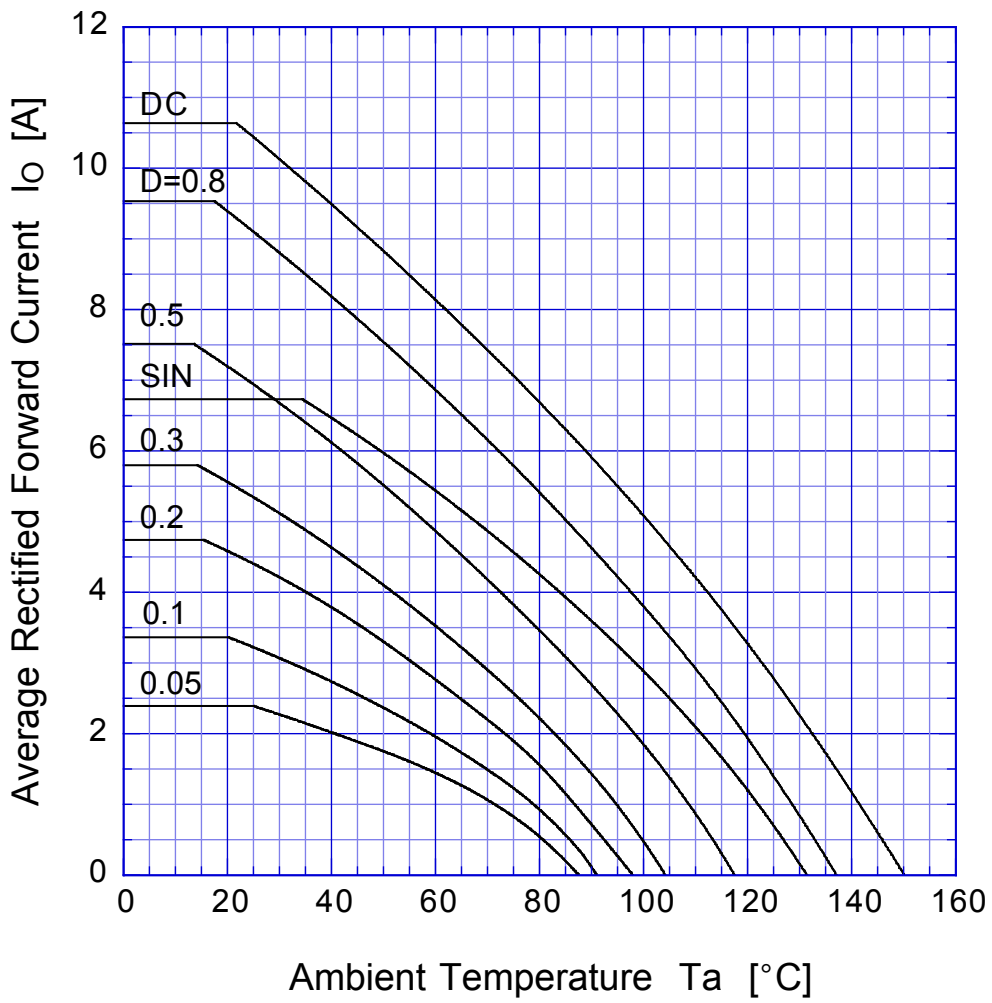

$V_R = 15V$

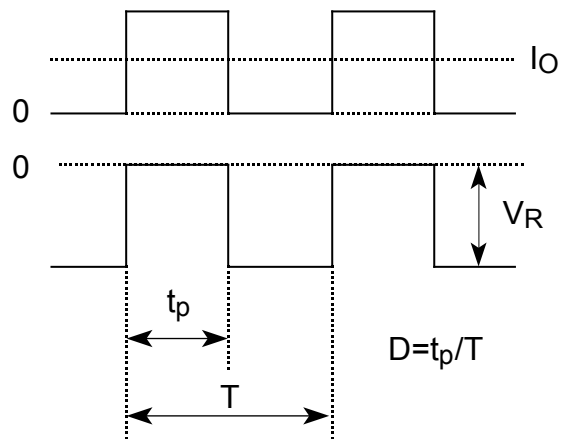

DF10SC4M Peak Surge Forward Capability

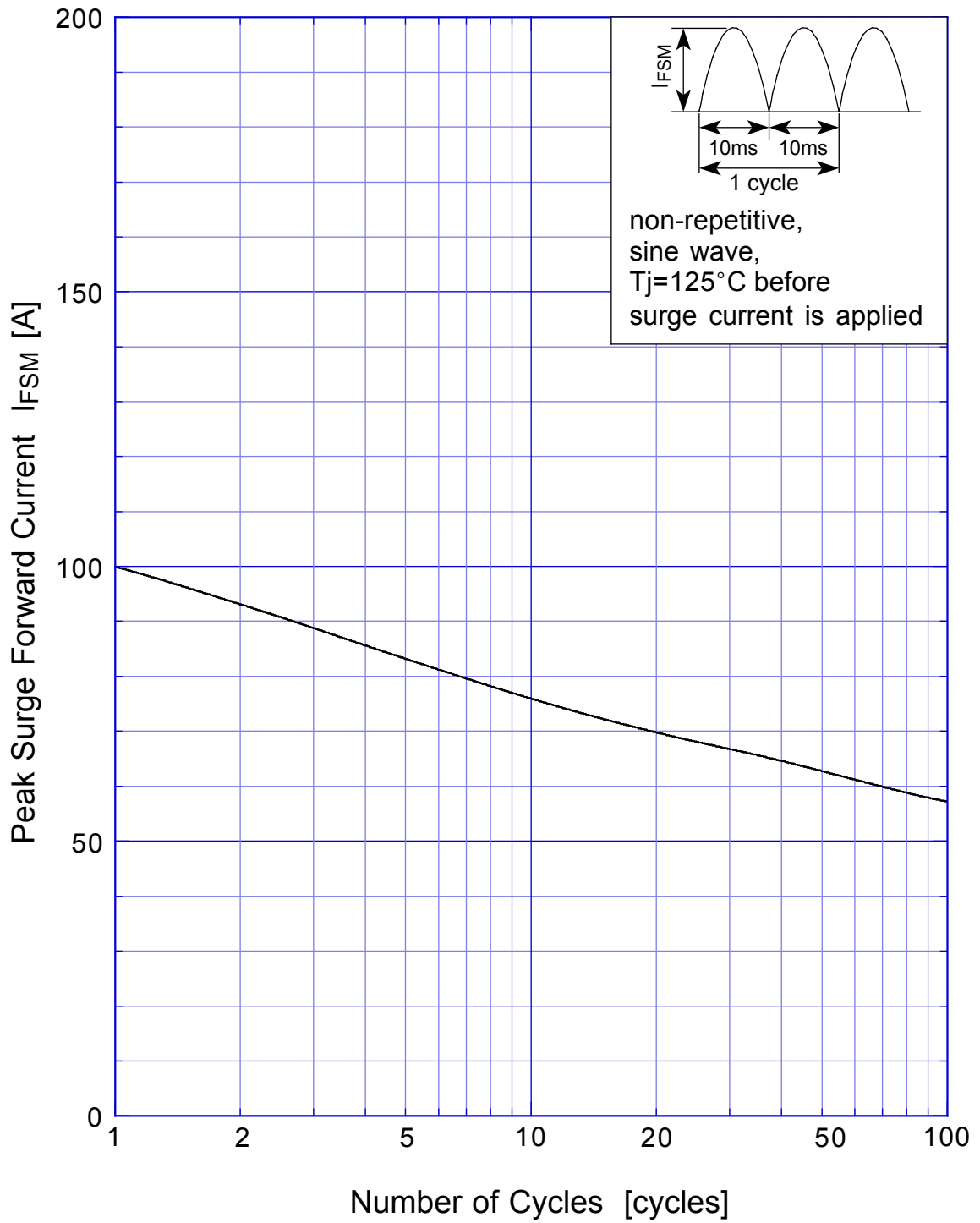

SBD Repetitive Surge Reverse Power Derating Curve

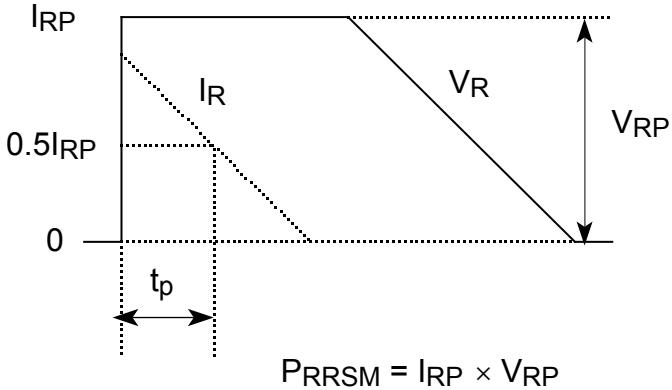
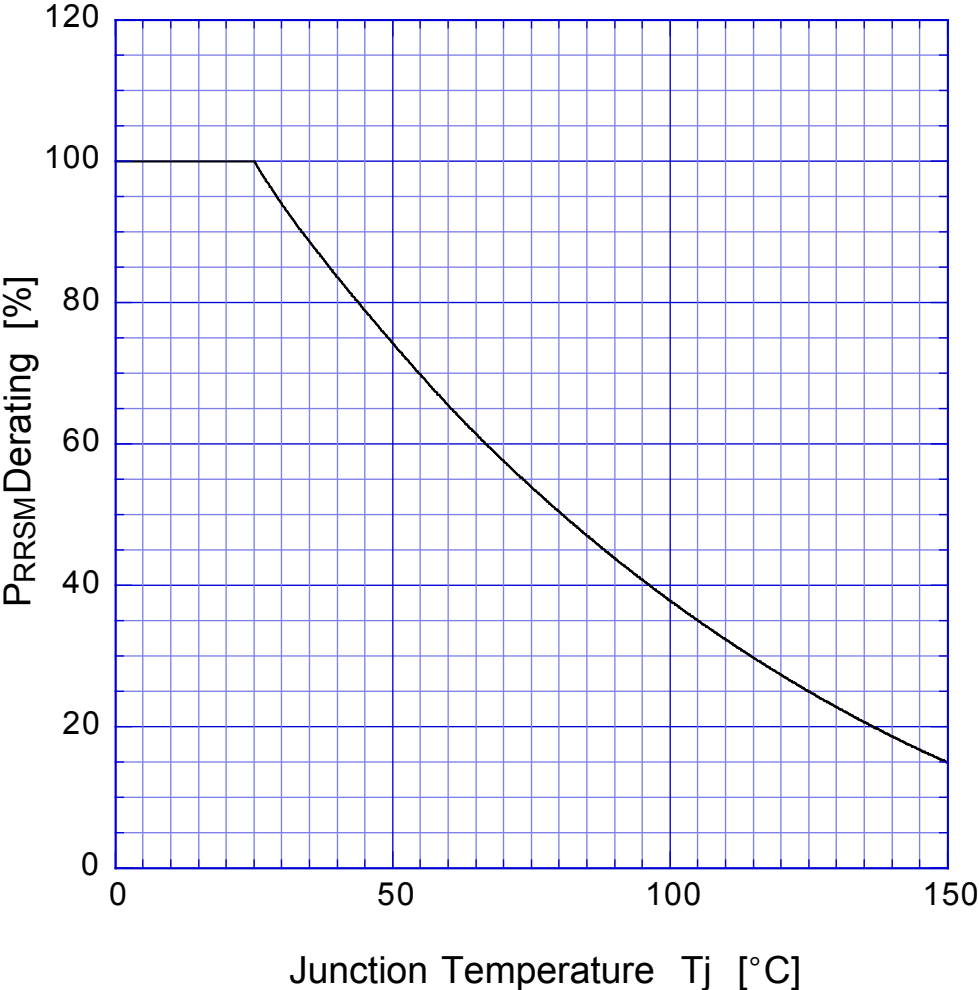

SBD

Repetitive Surge Reverse Power Capability

